

AZzardo[®]



New collection 2024

technoline

AZZARDO®



BULGARIA
VISTA_G LTD
tel.: +359 32 655 877
mobile: +359 888 579 030
e-mail: sales@iml.bg
• www.vista-g.com



POLAND
AZZARDO SP. Z O.O.
tel.: +48 61 849 40 80
fax: +48 61 849 40 84
e-mail: office@azzardolighting.com
• www.azzardolighting.com



UKRAINE
ELEKOMP
82107 LVIV REGION,
M.DROHOBYCZ VUL. GRUSHEWSKOGO 58
fax: +38 0324 438328
tel.: +38 067 353 3757
tel.: +38 097 860 6839
e-mail: elekomp@ukr.net
• www.elekomp.com.ua



CROATIA
REP. OF BOSNIA
AND HERZEGOVINA
MONTENEGRO
REMBOL D.O.O.
KOPERNIKOVA 5; 10000 ZAGREB
tel.: +91 222 02 29
tel.: +91 520 12 54
e-mail: info@azzardo.com.hr
• www.azzardo.com.hr



PORTUGAL
DOMOLED
NÚCLEO EMPRESARIAL
DA ABRUNHEIRA ZONA
POENTE PAV.4, 2710-089 SINTRA
tel.: +351 219 111 201
tel.: +351 911 003 235
e-mail: geral@domoled.pt
• www.domoled.pt

PROFORMA
KYIV, EKS KAVATORNA 24
tel.: +38 098 193 22 22
tel.: +38 097 083 81 53
e-mail: zakaz@proforma.kiev.ua
• www.proforma.com.ua



CZECH REPUBLIC
AZZARDO LIGHTING S.R.O.
tel.: +421 41 565 22 56
e-mail: info@azzardo.sk
• www.azzardodesign.com



ROMANIA
JACEK KREMPIŃSKI
tel.: +48 518 543 875
e-mail: jacekkrempinski@gmail.com



UNITED KINGDOM AND IRELAND
IAN DORMER
tel.: 07745 763251
e-mail: ian@eurolamps.uk



HUNGARY
ELTER LTD.
tel.: +36 20 203 4751
e-mail: info@elter.hu
• www.elter.hu



SLOVAKIA
AZZARDO LIGHTING S.R.O.
TEL.: +421 41 565 22 56
e-mail: info@azzardo.sk
• www.azzardodesign.com



ICELAND
PFAFF
tel.: +354 414 0400
fax: +354 414 0401
e-mail: pfaff@pfaff.is
• www.pfaff.is



NIGERIA
Lights & Finishings EnVogu
Silverado Mall, No. 1A Chief Collins Street,
Off Emma Abimbola Street
Lekki Phase 1, Lagos.
tel.: 08033458196
e-mail: lightingandfittingsev@gmail.com

AZzardo[®]

TECHNOLINE



ALFA

track magnetic

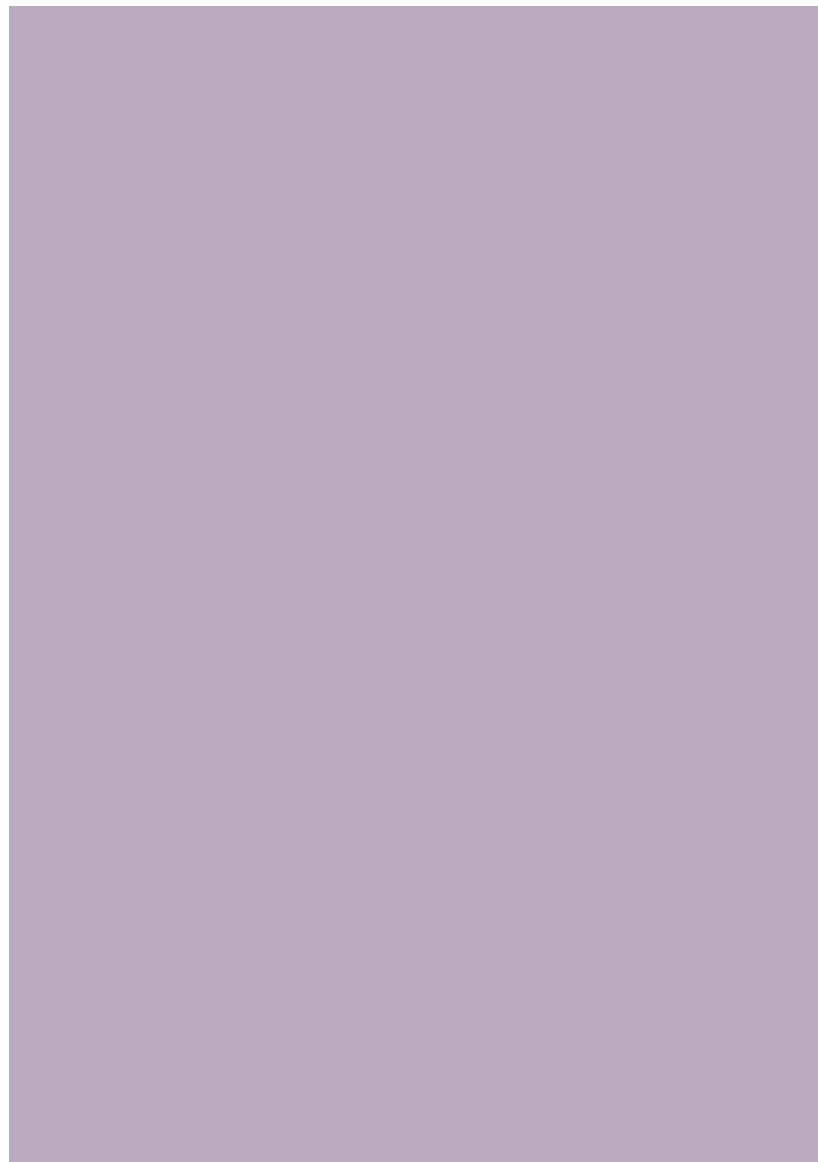



ALFA TRACK MAGNETIC EASYFIX (1m, 1.5m, 2m, 3m)

Colour / new index no.

- ALFA TRACK MAGNETIC EASYFIX 1m BK [AZ5676](#)
- ALFA TRACK MAGNETIC EASYFIX 1.5m BK [AZ5677](#)
- ALFA TRACK MAGNETIC EASYFIX 2m BK [AZ5678](#)
- ALFA TRACK MAGNETIC EASYFIX 3m BK [AZ5679](#)



ALFA TRACK MAGNETIC EASYFIX SPRING x3

- ALFA TRACK MAGNETIC EASYFIX SPRING x3 [AZ5680](#)



ALFA TRACK MAGNETIC EASYFIX SPRING x4

- ALFA TRACK MAGNETIC EASYFIX SPRING x4 [AZ5681](#)



ALFA TRACK MAGNETIC EASYFIX SPRING x5

- ALFA TRACK MAGNETIC EASYFIX SPRING x5 [AZ5683](#)



ALFA TRACK MAGNETIC EASYFIX SPRING x7

- ALFA TRACK MAGNETIC EASYFIX SPRING x7 AZ5684



ALFA TRACK MAGNETIC EASYFIX STRAIGHT END CAP BK

Colour / new index no.

- ALFA TRACK MAGNETIC EASYFIX STRAIGHT END CAP BK AZ5687



ALFA TRACK MAGNETIC STRETCH (1m, 2m, 3m)

Colour / new index no.

- | | |
|-------------------------------------|--------|
| ● ALFA TRACK MAGNETIC EASYFIX 1m BK | AZ5836 |
| ● ALFA TRACK MAGNETIC EASYFIX 2m BK | AZ5837 |
| ● ALFA TRACK MAGNETIC EASYFIX 3m BK | AZ5838 |

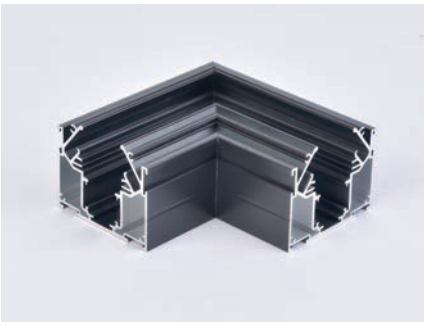

ALFA TRACK MAGNETIC STRETCH CORNER90 BK

- ALFA TRACK MAGNETIC STRETCH CORNER90 BK AZ5839

ALFA TRACK MAGNETIC STRETCH CONNECTOR x 4

- ALFA TRACK MAGNETIC STRETCH CONNECTOR x 4 AZ5840

ALFA TRACK MAGNETIC STRETCH END CAP BK

- ALFA TRACK MAGNETIC STRETCH END CAP BK AZ5641

ALFA TRACK MAGNETIC DRIVER 2LINE 60+60W INSIDE BK

- ALFA TRACK MAGNETIC DRIVER 2LINE 60+60W INSIDE BK AZ6230

**ALFA TRACK MAGNETIC DRIVER 2LINE 100+100W
INSIDE BK**

- ALFA TRACK MAGNETIC DRIVER 2LINE 100+100W INSIDE BK [AZ6232](#)

**ALFA TRACK MAGNETIC DRIVER 2LINE 60+60W
DIM INSIDE BK**

- ALFA TRACK MAGNETIC DRIVER 2LINE 60+60W DIM INSIDE BK [AZ6234](#)

**ALFA TRACK MAGNETIC DRIVER 2LINE 100+100W
DIM INSIDE BK**

- ALFA TRACK MAGNETIC DRIVER 2LINE 100+100W DIM INSIDE BK [AZ6235](#)

ALFA TRACK MAGNETIC DRIVER 100W INSIDE BK

- ALFA TRACK MAGNETIC DRIVER 2LINE 100+100W INSIDE BK [AZ4671](#)

ALFA TRACK MAGNETIC DRIVER 200W INSIDE BK

- ALFA TRACK MAGNETIC DRIVER 200W INSIDE BK [AZ4673](#)

**ALFA TRACK MAGNETIC DRIVER 60W DALI INSIDE
BK**

- ALFA TRACK MAGNETIC DRIVER 60W DALI INSIDE BK [AZ6283](#)

Option 1

- individual Turning ON/OFF LINE-1
- individual Turning ON/OFF LINE-2
- individual Dimable L1
- individual Dimable L2

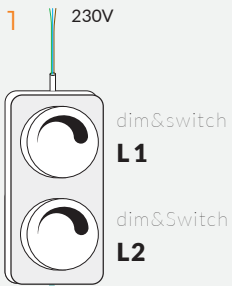

Option 2

- Turning on/off ONLY LINE-1
- Turning on/off ONLY LINE-2
- Dimable L1 & L2 – Together

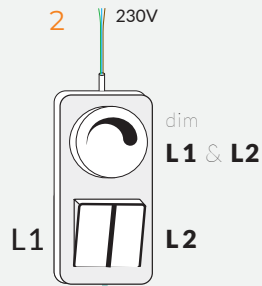

Option 3

- (Together Dimable&Turning);
- L1 & L2 Turning ON/OFF
 - Dimable L1 & L2 – Together

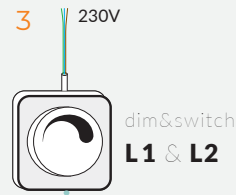

Option 4

- ONLY Turning;
- Turning on/off ONLY LINE-1
 - Turning on/off ONLY LINE-2

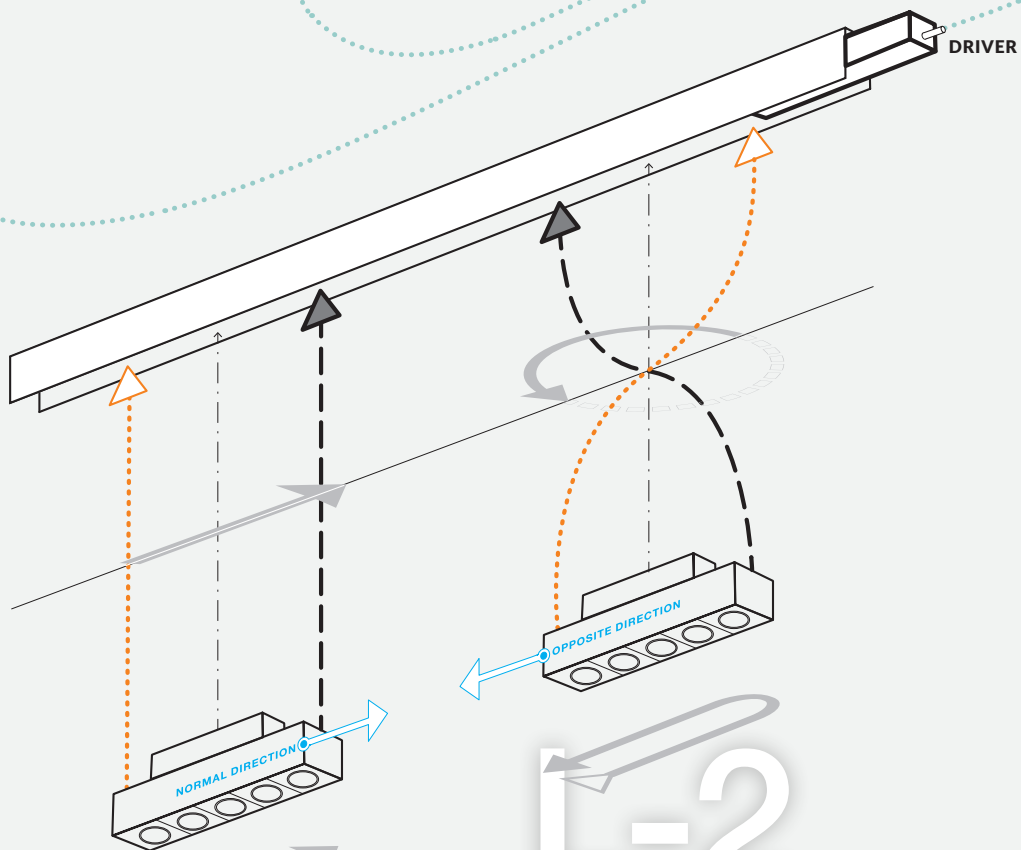
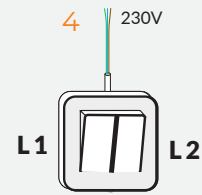

L-1
normal direction

L-2
change direction
– rotate 180

(Converst L-1 to L-2)
Turned the lamp 180°. Unplug to the track rail with opposite direction and replace it with LINE-2

ALFA 2LINE

track magnetic





ALFA SAGA TRACK MAGNETIC 2LINE 12W CCT SWITCH DIM BK

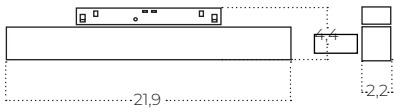

Name	Alfa Saga Track Magnetic 2line 12W CCT Switch DIM Bk
Power	12W
Light source	1 x LED integrated
Kelvins	3000 / 4000 / 6000K
Beam angle	120°
IP	IP20
Material	aluminium / PVC
Voltage	48V
Type of control	CCT switch+DIMMER

Technical specification

Colour / new index no.

- black AZ6236



ALFA SAGA TRACK MAGNETIC 2LINE 24W CCT SWITCH DIM BK

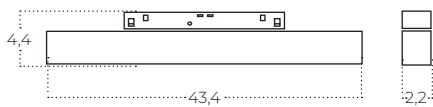

Name	Alfa Saga Track Magnetic 2line 24W CCT Switch DIM Bk
Power	24W
Light source	1 x LED integrated
Kelvins	3000 / 4000 / 6000K
Beam angle	120°
IP	IP20
Material	aluminium / PVC
Voltage	48V
Type of control	CCT switch+DIMMER

Technical specification

Colour / new index no.

- black AZ6237





ALFA SAGA TRACK MAGNETIC 2LINE 36W CCT SWITCH DIM BK

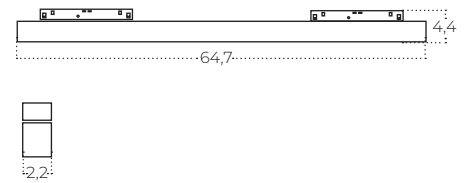

Name	Alfa Saga Track Magnetic 2line 36W CCT Switch DIM Bk
Power	36W
Light source	1 x LED integrated
Kelvins	3000 / 4000 / 6000K
Beam angle	120°
IP	IP20
Material	aluminium / PVC
Voltage	48V
Type of control	CCT switch+DIMMER

Technical specification

Colour / new index no.

● black AZ6238



ALFA SAGA TRACK MAGNETIC 2LINE 48W CCT SWITCH DIM BK

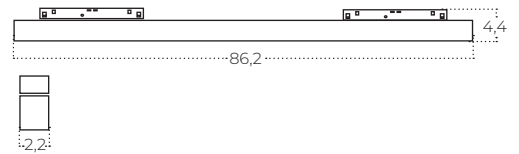

Name	Alfa Saga Track Magnetic 2line 48W CCT Switch DIM Bk
Power	48W
Light source	1 x LED integrated
Kelvins	3000 / 4000 / 6000K
Beam angle	120°
IP	IP20
Material	aluminium / PVC
Voltage	48V
Type of control	CCT switch+DIMMER

Technical specification

Colour / new index no.

● black AZ6239





ALFA KIRA TRACK MAGNETIC 2LINE 12W CCT SWITCH DIM BK

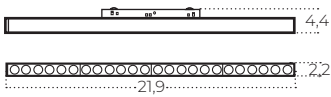

Name	Alfa Kira Track Magnetic 2line 12W CCT Switch DIM Bk
Power	12W
Light source	1 x LED integrated
Kelvins	3000 / 4000 / 6000K
Beam angle	120°
IP	IP20
Material	aluminium / PVC
Voltage	48V
Type of control	CCT switch+DIMMER

Technical specification

Colour / new index no.

- black AZ6240



ALFA KIRA TRACK MAGNETIC 2LINE 24W CCT SWITCH DIM BK

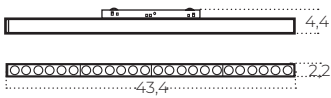

Name	Alfa Kira Track Magnetic 2line 24W CCT Switch DIM Bk
Power	24W
Light source	1 x LED integrated
Kelvins	3000 / 4000 / 6000K
Beam angle	120°
IP	IP20
Material	aluminium / PVC
Voltage	48V
Type of control	CCT switch+DIMMER

Technical specification

Colour / new index no.

- black AZ6241





ALFA KIRA TRACK MAGNETIC 2LINE 36W CCT SWITCH DIM BK

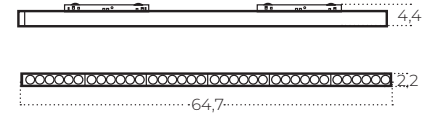

Technical specification

Colour / new index no.

- black AZ6242



Name	Alfa Kira Track Magnetic 2line 36W CCT Switch DIM Bk
Power	36W
Light source	1 x LED integrated
Kelvins	3000 / 4000 / 6000K
Beam angle	120°
IP	IP20
Material	aluminium / PVC
Voltage	48V
Type of control	CCT switch+DIMMER



ALFA KIRA TRACK MAGNETIC 2LINE 48W CCT SWITCH DIM BK

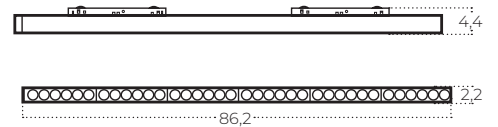

Technical specification

Colour / new index no.

- black AZ6243



Name	Alfa Kira Track Magnetic 2line 48W CCT Switch DIM Bk
Power	48W
Light source	1 x LED integrated
Kelvins	3000 / 4000 / 6000K
Beam angle	120°
IP	IP20
Material	aluminium / PVC
Voltage	48V
Type of control	CCT switch+DIMMER



ALFA SAGA TRACK MAGNETIC 2LINE CORNER A 24W CCT SWITCH DIM BK

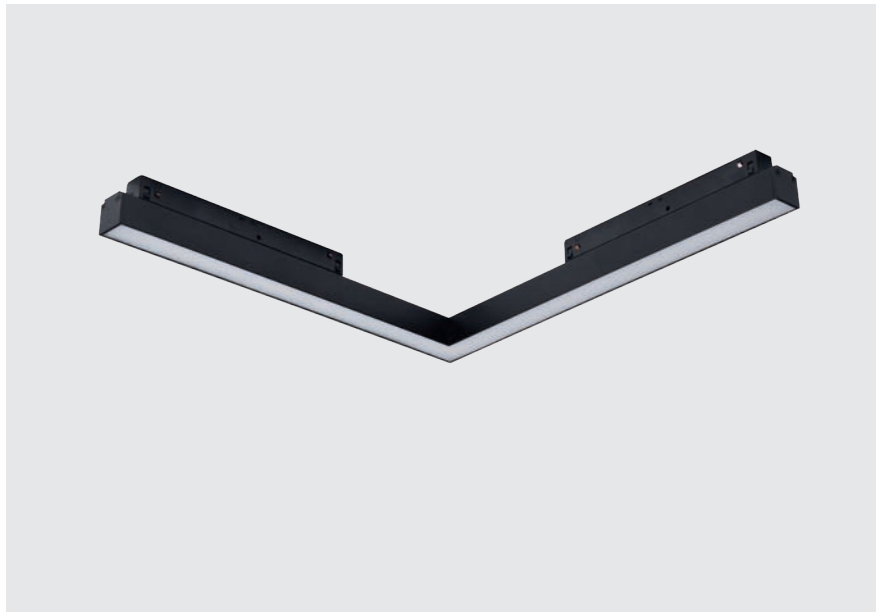
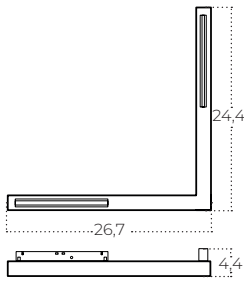

Name	Alfa Saga Track Magnetic 2line Corner A 24W CCT Switch DIM Bk
Power	24W
Light source	1 x LED integrated
Kelvins	3000 / 4000 / 6000K
Beam angle	120°
IP	IP20
Material	aluminium / PVC
Voltage	48V
Type of control	CCT switch+DIMMER + PHASE switch

Technical specification

Colour / new index no.

- black AZ6244



ALFA SAGA TRACK MAGNETIC 2LINE CORNER B 24W CCT SWITCH DIM BK

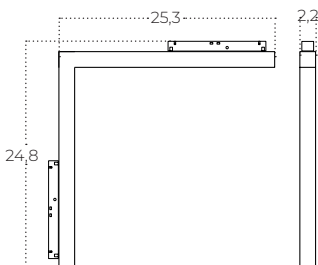

Name	Alfa Saga Track Magnetic 2line Corner B 24W CCT Switch DIM Bk
Power	24W
Light source	1 x LED integrated
Kelvins	3000 / 4000 / 6000K
Beam angle	120°
IP	IP20
Material	aluminium / PVC
Voltage	48V
Type of control	CCT switch+DIMMER + PHASE switch

Technical specification

Colour / new index no.

- black AZ6245





ALFA KIRA TRACK MAGNETIC 2LINE 12W CCT SWITCH DIM BK



Name	Alfa KIRA Track Magnetic 2line 12w CCT Switch DIM Bk
Power	12W
Light source	1 x LED integrated
Kelvins	3000 / 4000 / 6000K
Beam angle	24° / 36°
IP	IP20
Material	aluminium / PVC
Voltage	48V
Type of control	CCT switch+DIMMER

Technical specification

Colour / new index no.

- black AZ6246



ALFA KIRA TRACK MAGNETIC 2LINE 24W CCT SWITCH DIM BK



Name	Alfa KIRA Track Magnetic 2line 24W CCT Switch DIM Bk
Power	24W
Light source	1 x LED integrated
Kelvins	3000 / 4000 / 6000K
Beam angle	24° / 36°
IP	IP20
Material	aluminium / PVC
Voltage	48V
Type of control	CCT switch+DIMMER

Technical specification

Colour / new index no.

- black AZ6247





ALFA KIRA TRACK MAGNETIC 2LINE 36W CCT SWITCH DIM BK



Name	Alfa Kira Track Magnetic 2line 24W CCT Switch DIM Bk
Power	24W
Light source	1 x LED integrated
Kelvins	3000 / 4000 / 6000K
Beam angle	24° / 36°
IP	IP20
Material	aluminium / PVC
Voltage	48V
Type of control	CCT switch+DIMMER

Technical specification

Colour / new index no.

- black AZ6248



ALFA NIKO TRACK MAGNETIC 2LINE 7W CCT SWITCH DIM BK

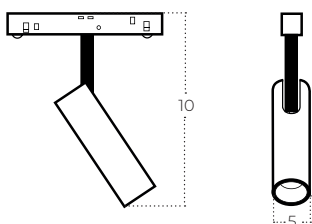

Name	Alfa Niko Track Magnetic 2line 7W CCT Switch DIM Bk
Power	7W
Light source	1 x LED integrated
Kelvins	3000 / 4000 / 6000K
Beam angle	24°/ 38°
IP	IP20
Material	aluminium / PVC
Voltage	48V
Type of control	CCT switch+DIMMER

Technical specification

Colour / new index no.

- black AZ6249





ALFA NIKO TRACK MAGNETIC 2LINE 12W CCT SWITCH DIM BK

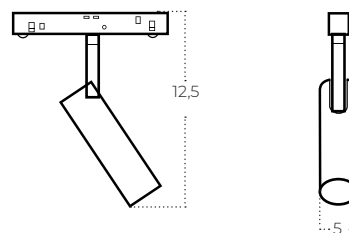

Name	Alfa Niko Track Magnetic 2line 12W CCT Switch DIM Bk
Power	12W
Light source	1 x LED integrated
Kelvins	3000 / 4000 / 6000K
Beam angle	24°/ 38°
IP	IP20
Material	aluminium / PVC
Voltage	48V
Type of control	CCT switch+DIMMER

Technical specification

Colour / new index no.

- black AZ6250



ALFA NIKO TRACK MAGNETIC 2LINE 20W CCT SWITCH DIM BK

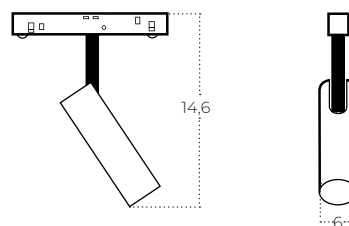

Name	Alfa Niko Track Magnetic 2line 20W CCT Switch DIM Bk
Power	20W
Light source	1 x LED integrated
Kelvins	3000 / 4000 / 6000K
Beam angle	24°/ 38°
IP	IP20
Material	aluminium / PVC
Voltage	48V
Type of control	CCT switch+DIMMER

Technical specification

Colour / new index no.

- black AZ6251





ALFA NIKO 2 TRACK MAGNETIC 2LINE 2X7W CCT SWITCH DIM BK

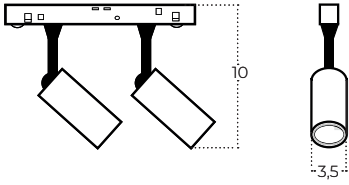

Name	Alfa Niko 2 Track Magnetic 2line 2x7W CCT Switch DIM Bk
Power	2 x 7W
Light source	2 x LED integrated
Kelvins	3000 / 4000 / 6000K
Beam angle	24°
IP	IP20
Material	aluminium / PVC
Voltage	48V
Type of control	CCT switch+DIMMER

Technical specification

Colour / new index no.

- black [AZ6252](#)



ALFA NIKO 2 TRACK MAGNETIC 2LINE 2X12W CCT SWITCH DIM BK

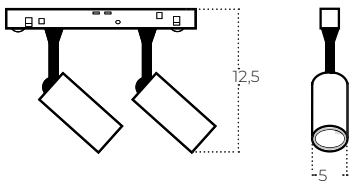

Name	Alfa Niko 2 Track Magnetic 2line 2x12W CCT Switch DIM Bk
Power	2 x 12W
Light source	2 x LED integrated
Kelvins	3000 / 4000 / 6000K
Beam angle	24°
IP	IP20
Material	aluminium / PVC
Voltage	48V
Type of control	CCT switch+DIMMER

Technical specification

Colour / new index no.

- black [AZ6253](#)





ALFA MITUS TRACK MAGNETIC 2LINE 18W CCT SWITCH DIM BK

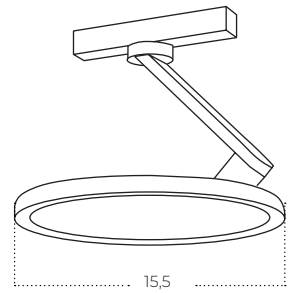

Name	Alfa Mitus Track Magnetic 2line 18W CCT Switch DIM Bk
Power	18W
Light source	1 x LED integrated
Kelvins	3000 / 4000 / 6000K
Beam angle	24°/ 38°
IP	IP20
Material	aluminium / PVC
Voltage	48V
Type of control	CCT switch+DIMMER

Technical specification



Colour / new index no.

- black AZ6257





ALFA DALI

track magnetic





ALFA DALI SAGA TRACK MAGNETIC 12W CCT DIMM BK

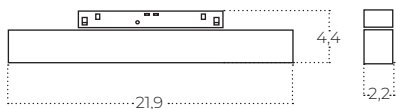

Name	Alfa Dali Saga Track Magnetic 12W CCT DIM Bk
Power	12W
Light source	1 x LED integrated
Kelvins	3000-6000 K
Beam angle	120°
IP	IP20
Material	aluminium / PVC
Voltage	48V
Type of control	SYSTEM DALI - DIMM / CCT

Technical specification

Colour / new index no.

- black AZ6284



ALFA DALI SAGA TRACK MAGNETIC 24W CCT DIMM BK

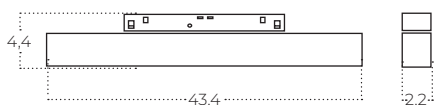

Name	Alfa Dali Saga Track Magnetic 24W CCT DIM Bk
Power	24W
Light source	1 x LED integrated
Kelvins	3000-6000 K
Beam angle	120°
IP	IP20
Material	aluminium / PVC
Voltage	48V
Type of control	SYSTEM DALI - DIMM / CCT

Technical specification

Colour / new index no.

- black AZ6285



ALFA DALI SAGA TRACK MAGNETIC 24W CORNER A CCT DIMM BK

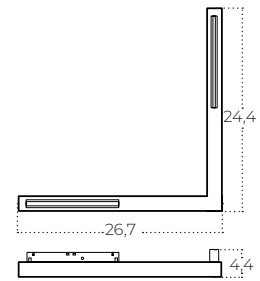
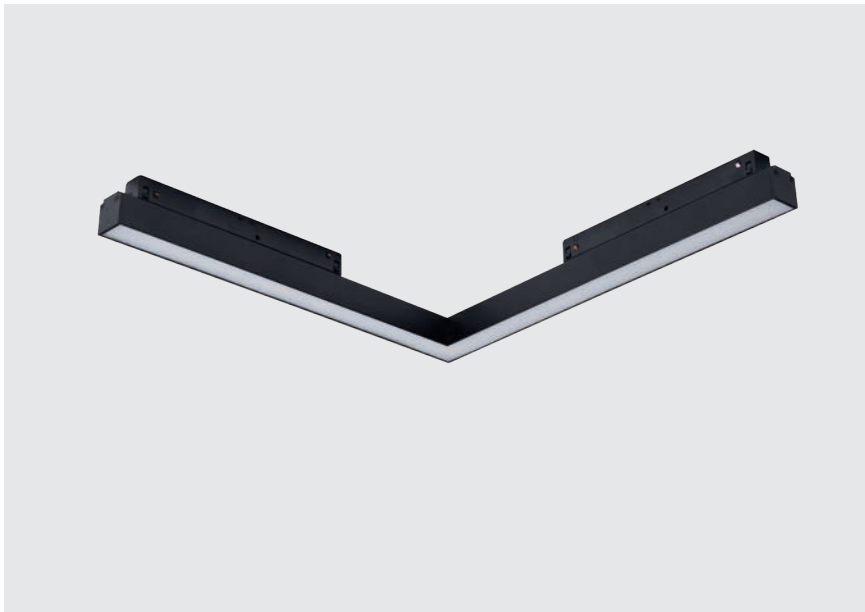

Name	Alfa DALI Saga Track Magnetic Corner A 24W CCT Switch DIM Bk
Power	24W
Light source	1 x LED integrated
Kelvins	3000 - 6000K
Beam angle	120°
IP	IP20
Material	aluminium / PVC
Voltage	48V
Type of control	SYSTEM DALI - DIMM / CCT

Technical specification

Colour / new index no.

- black AZ6288



ALFA DALI SAGA TRACK MAGNETIC CORNER B 24W CCT SWITCH DIM BK

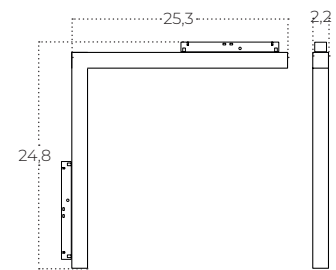

Name	Alfa DALI Saga Track Magnetic Corner B 24W CCT Switch DIM Bk
Power	24W
Light source	1 x LED integrated
Kelvins	3000 - 6000K
Beam angle	120°
IP	IP20
Material	aluminium / PVC
Voltage	48V
Type of control	SYSTEM DALI - DIMM / CCT

Technical specification

Colour / new index no.

- black AZ6289





ALFA DALI KIRA TRACK MAGNETIC 12W CCT DIMM BK

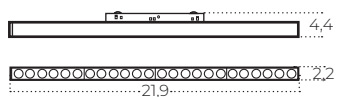

Name	Alfa DALI Kira Track Magnetic 12W CCT Switch DIM Bk
Power	12W
Light source	1 x LED integrated
Kelvins	3000-6000 K
Beam angle	120°
IP	IP20
Material	aluminium / PVC
Voltage	48V
Type of control	SYSTEM DALI - DIMM / CCT

Technical specification

Colour / new index no.

- black AZ6286



ALFA DALI KIRA TRACK MAGNETIC 24W CCT DIMM BK

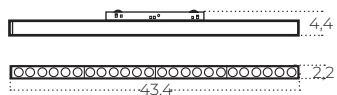

Name	Alfa DALI Kira Track Magnetic 24W CCT Switch DIM Bk
Power	24W
Light source	1 x LED integrated
Kelvins	3000-6000 K
Beam angle	120°
IP	IP20
Material	aluminium / PVC
Voltage	48V
Type of control	SYSTEM DALI - DIMM / CCT

Technical specification

Colour / new index no.

- black AZ6287





ALFA DALI NIKO TRACK MAGNETIC 7W CCT SWITCH DIM BK

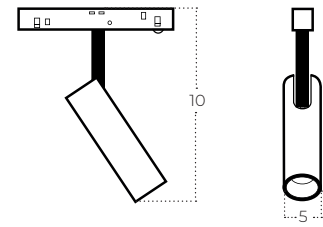

Name	Alfa Niko Track Magnetic 2line 7W CCT Switch DIM Bk
Power	7W
Light source	1 x LED integrated
Kelvins	3000 / 4000 / 6000K
Beam angle	24° / 38°
IP	IP20
Material	aluminium / PVC
Voltage	48V
Type of control	SYSTEM DALI - DIMM / CCT

Technical specification

Colour / new index no.

- black AZ6290



ALFA DALI NIKO TRACK MAGNETIC 12W CCT SWITCH DIM BK

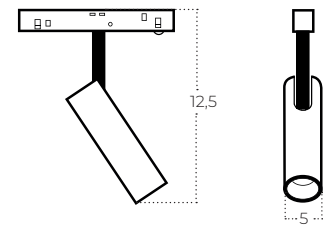

Name	Alfa Niko Track Magnetic 2line 7W CCT Switch DIM Bk
Power	7W
Light source	1 x LED integrated
Kelvins	3000 / 4000 / 6000K
Beam angle	24° / 38°
IP	IP20
Material	aluminium / PVC
Voltage	48V
Type of control	SYSTEM DALI - DIMM / CCT

Technical specification

Colour / new index no.

- black AZ6291





ALFA DALI NIKO TRACK MAGNETIC 20W CCT SWITCH DIM BK

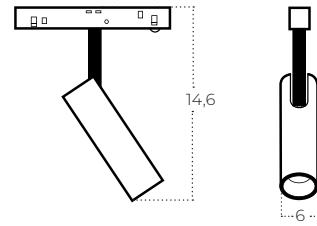

Name	Alfa Dali Niko Track Magnetic 20W CCT Switch DIM Bk
Power	20W
Light source	1 x LED integrated
Kelvins	3000 / 4000 / 6000K
Beam angle	24°/ 38°
IP	IP20
Material	aluminium / PVC
Voltage	48V
Type of control	SYSTEM DALI - DIMM / CCT

Technical specification



Colour / new index no.

- black AZ6292



ALFA DALI NIKO 2 TRACK MAGNETIC 2X12W CCT SWITCH DIM BK

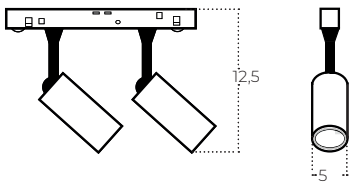

Name	Alfa Dali Niko 2 Track Magnetic 2x12W CCT Switch DIM Bk
Power	2 x 12W
Light source	2 x LED integrated
Kelvins	3000 / 4000 / 6000K
Beam angle	24°
IP	IP20
Material	aluminium / PVC
Voltage	48V
Type of control	SYSTEM DALI - DIMM / CCT

Technical specification



Colour / new index no.

- black AZ6293



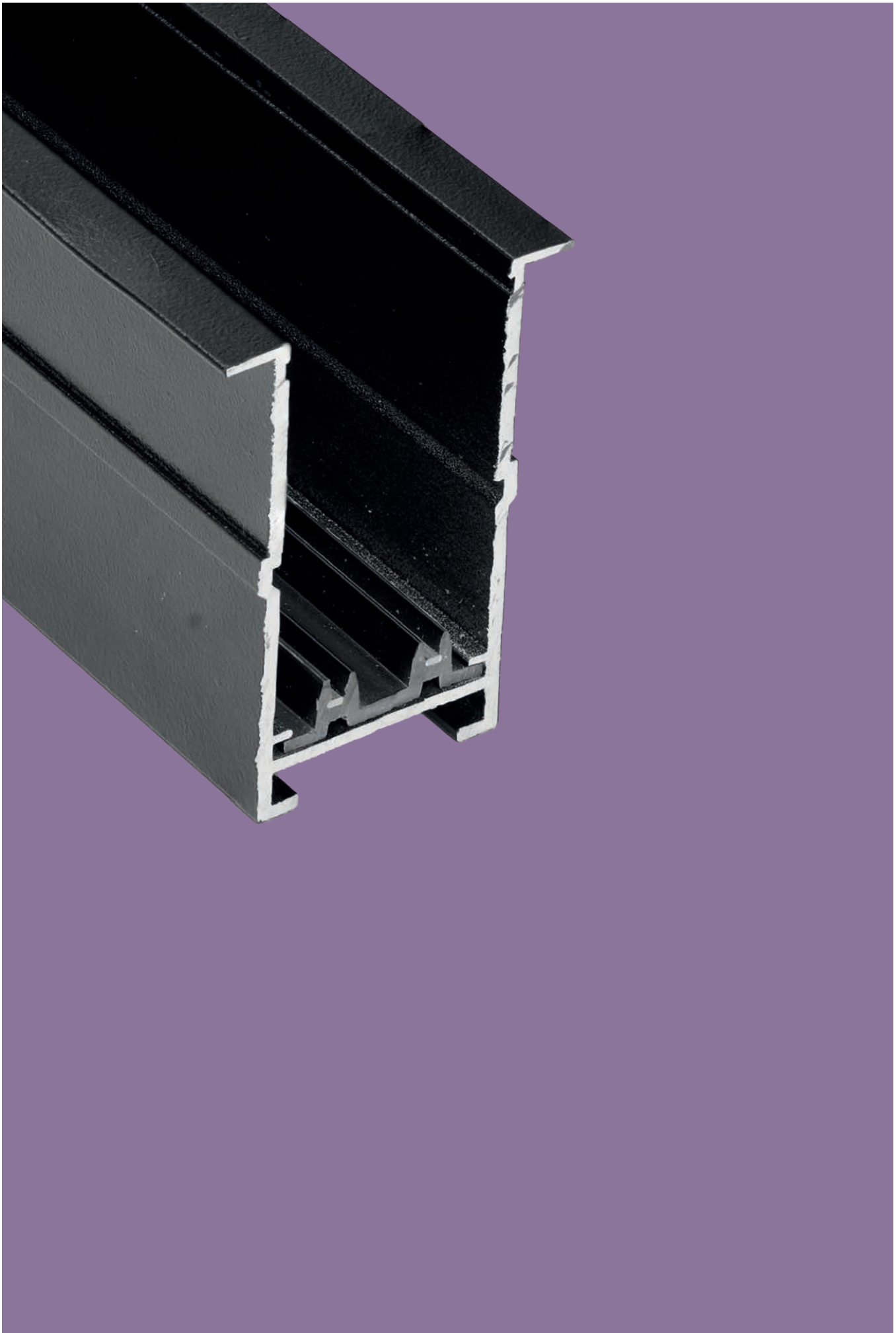

BETA

track magnetic





Beta Track Magnetic50 Easyfix 230V (1m, 2m, 3m)

Colour / new index no.

- BETA TRACK MAGNETIC50 EASYFIX 230V 1m [AZ6067](#)
- BETA TRACK MAGNETIC50 EASYFIX 230V 2m [AZ6068](#)
- BETA TRACK MAGNETIC50 EASYFIX 230V 3m [AZ6069](#)



BETA TRACK MAGNETIC50 EASYFIX 230V CORNER90 A BK

- BETA TRACK MAGNETIC50 EASYFIX 230V CORNER90 A BK [AZ6072](#)



BETA TRACK MAGNETIC50 EASYFIX 230V CORNER90 B BK

- BETA TRACK MAGNETIC50 EASYFIX 230V CORNER90 B BK [AZ6073](#)



BETA TRACK MAGNETIC 230V STRAIGHT CONNECTOR MECHANICAL BK

- BETA TRACK MAGNETIC 230V STRAIGHT CONNECTOR MECHANICAL BK [AZ5151](#)

**BETA TRACK MAGNETIC50 EASYFIX 230V
MOUNTING PLATE**

- BETA TRACK MAGNETIC50 EASYFIX 230V
MOUNTING PLATE

AZ6070

**BETA TRACK MAGNETIC50 EASYFIX 230V
END CAP BK**

- BETA TRACK MAGNETIC50 EASYFIX 230V
END CAP BK

AZ6074

**BETA TRACK MAGNETIC50 EASYFIX
230V SPRING x1**

- BETA TRACK MAGNETIC50 EASYFIX
230V SPRING x1

AZ6071



INDOOR

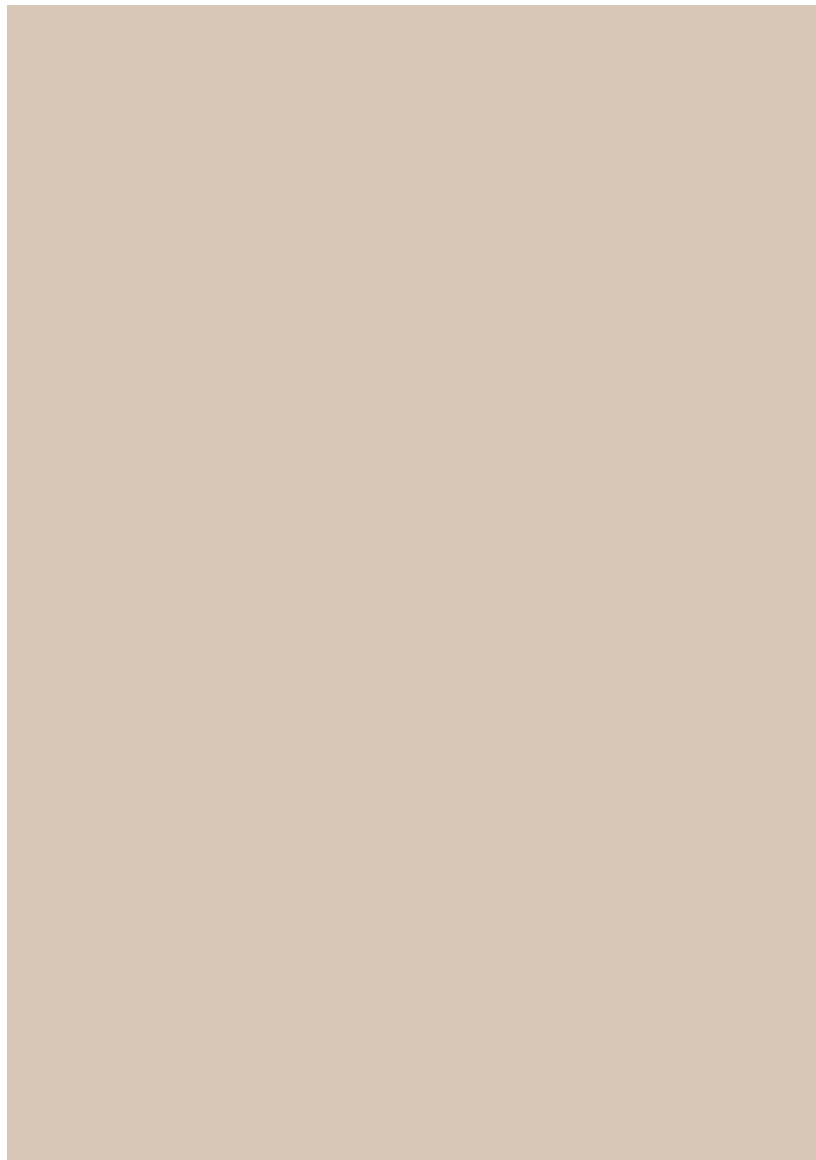



LINELIO OPAL 67 CCT DIMM BK

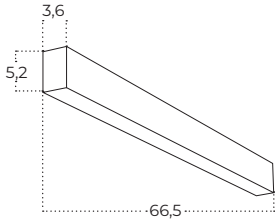

Name	Linelio Opal 67 CCT DIMM
IP	IP20
Material	aluminium / pvc
Light source	1 x LED INTEGRATED
Power	24W
Kelvins	3000 / 4000 / 6500K
Lumens	154lm
Beam angle	120°
CCT	SWITCH
Dimmable	YES

Technical specification

Colour / new index no.

- black AZ5656



LINELIO OPAL 120 CCT DIMM BK

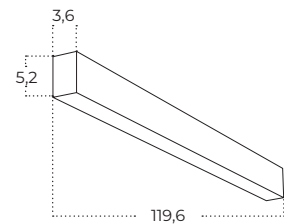

Name	Linelio Opal 120 CCT DIMM
IP	IP20
Material	aluminium / pvc
Light source	1 x LED INTEGRATED
Power	40W
Kelvins	3000 / 4000 / 6500K
Lumens	2700lm
Beam angle	120°
CCT	SWITCH
Dimmable	YES

Technical specification

Colour / new index no.

- black AZ5657





LINELIO OPAL 212 CCT DIMM BK

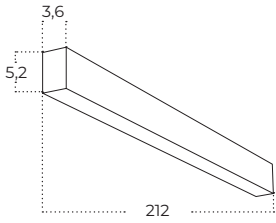

Name	Linelio Opal 212 CCT DIMM
IP	IP20
Material	aluminium / pvc
Light source	1 x LED INTEGRATED
Power	60W
Kelvins	3000 / 4000 / 6500K
Lumens	4024lm
Beam angle	120°
CCT	SWITCH
Dimmable	YES

Technical specification

Colour / new index no.

- black AZ5658



LINELIO OPAL 318 CCT DIMM BK

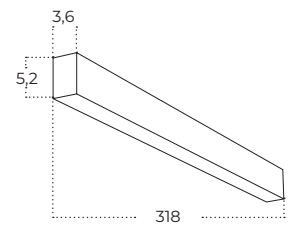

Name	Linelio Opal 318 CCT DIMM
IP	IP20
Material	aluminium / pvc
Light source	1 x LED INTEGRATED
Power	90W
Kelvins	3000 / 4000 / 6500K
Lumens	6248lm
Beam angle	120°
CCT	SWITCH
Dimmable	YES

Technical specification

Colour / new index no.

- black AZ5659





LINELIO MIX 67 CCT DIMM

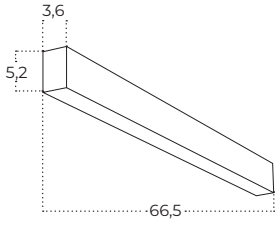

Name	Linelio MIX 67 CCT DIMM
IP	IP20
Material	aluminium / pvc
Light source	1 x LED INTEGRATED
Power	24W
Kelvins	3000 / 4000 / 6500K
Lumens	1576lm
Beam angle	30° + 120°
CCT	SWITCH
Dimmable	YES

Colour / new index no.

- black AZ5660
- white AZ5661

Technical specification



LINELIO MIX 120 CCT DIMM

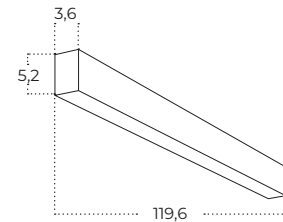

Name	Linelio MIX 120 CCT DIMM
IP	IP20
Material	aluminium / pvc
Light source	1 x LED INTEGRATED
Power	40W
Kelvins	3000 / 4000 / 6500K
Lumens	2753lm
Beam angle	30° + 120°
CCT	SWITCH
Dimmable	YES

Colour / new index no.

- black AZ5662
- white AZ5663

Technical specification





LINELIO MIX 212 CCT DIMM

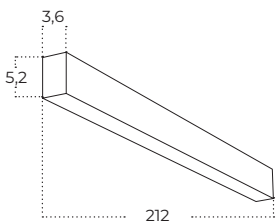

Name	Linelio MIX 212 CCT DIMM
IP	IP20
Material	aluminium / pvc
Light source	1 x LED INTEGRATED
Power	60W
Kelvins	3000 / 4000 / 6500K
Lumens	4164lm
Beam angle	30° + 120°
CCT	SWITCH
Dimmable	YES

Colour / new index no.

- black AZ5664

- white AZ5665

Technical specification



LINELIO MIX 318 CCT DIMM

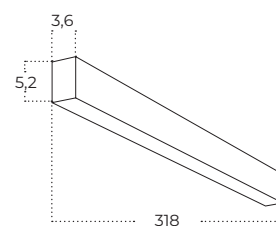

Name	Linelio MIX 318 CCT DIMM
IP	IP20
Material	aluminium / pvc
Light source	1 x LED INTEGRATED
Power	90W
Kelvins	3000 / 4000 / 6500K
Lumens	6512lm
Beam angle	30° + 120°
CCT	SWITCH
Dimmable	YES

Colour / new index no.

- black AZ5666

- white AZ5667

Technical specification





LINELIO POINTS 67 CCT DIMM

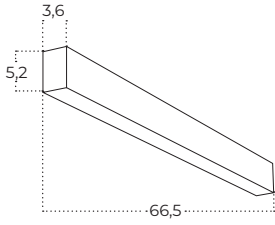

Name	Linelio POINTS 67 CCT DIMM
IP	IP20
Material	aluminium / pvc
Light source	1 x LED INTEGRATED
Power	24W
Kelvins	3000 / 4000 / 6500K
Lumens	1572m
Beam angle	30°
CCT	SWITCH
Dimmable	YES

Technical specification

Colour / new index no.

- black AZ5668



LINELIO POINTS 120 CCT DIMM

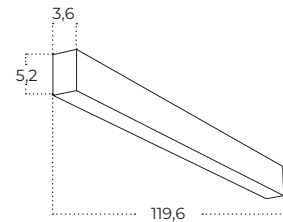

Name	Linelio POINTS 120 CCT DIMM
IP	IP20
Material	aluminium / pvc
Light source	1 x LED INTEGRATED
Power	40W
Kelvins	3000 / 4000 / 6500K
Lumens	2624lm
Beam angle	30°
CCT	SWITCH
Dimmable	YES

Technical specification

Colour / new index no.

- black AZ5669





LINELIO POINTS 212 CCT DIMM

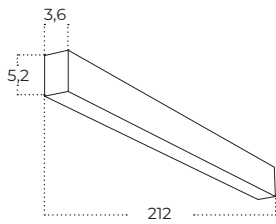

Name	Linelio POINTS 212 CCT DIMM
IP	IP20
Material	aluminium / pvc
Light source	1 x LED INTEGRATED
Power	60W
Kelvins	3000 / 4000 / 6500K
Lumens	4151lm
Beam angle	30°
CCT	SWITCH
Dimmable	YES

Technical specification

Colour / new index no.

- black
- AZ5670



LINELIO POINTS 318 CCT DIMM

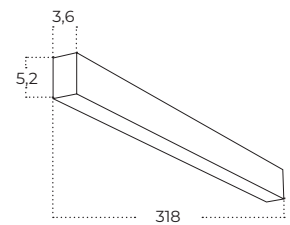

Name	Linelio POINTS 318 CCT DIMM
IP	IP20
Material	aluminium / pvc
Light source	1 x LED INTEGRATED
Power	90W
Kelvins	3000 / 4000 / 6500K
Lumens	6502lm
Beam angle	30°
CCT	SWITCH
Dimmable	YES

Technical specification

Colour / new index no.

- black
- AZ5671





OLIMPIA WALL 2

Technical specification



Name	OLIMPIA WALL 2 BK	OLIMPIA WALL 2 WH
IP	IP20	IP20
Material	aluminium/PVC	aluminium/PVC
Light source	2 x LED INTEGRATED	2 x LED INTEGRATED
Power	5W+3W	5W+3W
Kelvins	3000K	3000K
Lumens	400+240lm	400+240lm

Colour / new index no.

● sand black [AZ5965](#)

○ sand white [AZ5966](#)







EXPOSED

downlights







WIKING 12W CCT SWITCH

Technical specification

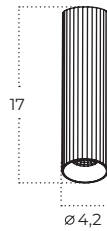

Name	WIKING 12W CCT SWITCH
IP	IP20
Material	aluminium
Light source	1 x LED INTEGRATED
Power	12W
Kelvins	3000/4000/6000K
Lumens	960lm

Colour / new index no.

- matt black AZ5970
- matt white AZ5971
- gold AZ5972



WIKING 18W CCT SWITCH

Technical specification



Name	WIKING 18W CCT SWITCH
IP	IP20
Material	aluminium
Light source	1 x LED INTEGRATED
Power	15W
Kelvins	3000/4000/6000K
Lumens	1440lm

Colour / new index no.

- matt black AZ5973
- matt white AZ5974
- gold AZ5975



COSTA 12W CCT SWITCH

Technical specification

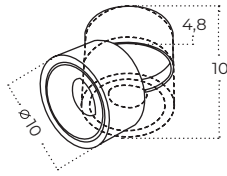

	COSTA 12W CCT SWITCH BK	COSTA 12W CCT SWITCH WH
Name	COSTA 12W CCT SWITCH BK	COSTA 12W CCT SWITCH WH
IP	IP20	IP20
Material	aluminium	aluminium
Light source	1 x LED INTEGRATED	1 x LED INTEGRATED
Power	12W	12W
Kelvins	3000 / 4000 / 6000K	3000 / 4000 / 6000K
Lumens	960lm	960lm
CCT	3-STEP	3-STEP
Tilt	90°	90°
Rotation	350°	350°

Colour / new index no.

- black AZ6031
- white AZ6032



COSTA TOP 12W CCT SWITCH

Technical specification

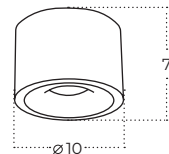

	COSTA TOP 12W CCT SWITCH BK	COSTA TOP 12W CCT SWITCH WH
Name	COSTA TOP 12W CCT SWITCH BK	COSTA TOP 12W CCT SWITCH WH
IP	IP20	IP20
Material	aluminium	aluminium
Light source	1 x LED INTEGRATED	1 x LED INTEGRATED
Power	12W	12W
Kelvins	3000 / 4000 / 6000K	3000 / 4000 / 6000K
Lumens	960lm	960lm
CCT	3-STEP	3-STEP

Colour / new index no.

- black AZ6033
- white AZ6034



COSTA 3000/4000K

Technical specification

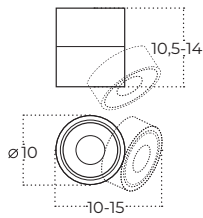

Name	COSTA	COSTA
IP	IP20	IP20
Material	aluminium	aluminium
Light source	1 x LED INTEGRATED	1 x LED INTEGRATED
Power	12W	12W
Kelvins	3000K	4000K
Lumens	1000lm	1100lm
Tilt	90°	90°
Rotation	350°	350°

Colour / new index no.

○ 3000K	white	AZ2856
● 3000K	black	AZ2857
○ 4000K	white	AZ4554
● 4000K	black	AZ4553



COSTA SPOT

Technical specification

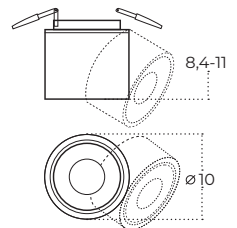

Name	COSTA SPOT BK	COSTA SPOT WH
IP	IP20	IP20
Material	aluminium	aluminium
Light source	1 x LED INTEGRATED	1 x LED INTEGRATED
Power	12W	12W
Kelvins	3000K	3000K
Lumens	1020lm	1020m
Tilt	90°	90°
Rotation	350°	350°

Colour / new index no.

○ 3000K	white	AZ2705
● 3000K	black	AZ2706



COSTA ARM

Technical specification

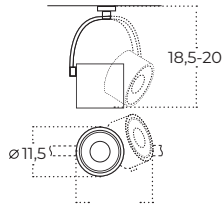

Name	COSTA ARM BK	COSTA ARM WH
IP	IP20	IP20
Material	aluminium	aluminium
Light source	1 x LED INTEGRATED	1 x LED INTEGRATED
Power	12W	12W
Kelvins	3000K	3000K
Lumens	1020lm	1020m
Tilt	90°	90°
Rotation	350°	350°

Colour / new index no.

○ white [AZ2703](#)

● black [AZ2702](#)



MONA 12W

Technical specification

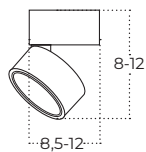

Name	MONA 15W CCT SWITCH BK	MONA 15W CCT SWITCH WH
IP	IP20	IP20
Material	aluminium / pvc	aluminium / pvc
Light source	1 x LED INTEGRATED	1 x LED INTEGRATED
Power	15W	15W
Kelvins	3000 / 4000 / 6000K	3000 / 4000 / 6000K
Lumens	1200lm	1200lm
CCT	3-STEP	3-STEP
Tilt	90°	90°
Rotation	350°	350°

Colour / new index no.

○ 3000K white [AZ4538](#)

● 3000K black [AZ4537](#)

○ 4000K white [AZ4540](#)

● 4000K black [AZ4539](#)





MONA 10W CCT SWITCH



Technical specification

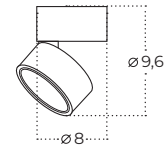

Name	MONA 10W CCT SWITCH BK	MONA 10W CCT SWITCH WH
IP	IP20	IP20
Material	aluminium / pvc	aluminium / pvc
Light source	1 x LED INTEGRATED	1 x LED INTEGRATED
Power	10W	10W
Kelvins	3000 / 4000 / 6000K	3000 / 4000 / 6000K
Lumens	800lm	800lm
CCT	3-STEP	3-STEP
Tilt	90°	90°
Rotation	350°	350°

Colour / new index no.

● black [AZ6035](#)○ white [AZ6036](#)

MONA 15W CCT SWITCH



Technical specification

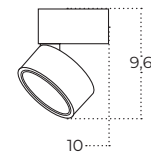

Name	MONA 15W CCT SWITCH BK	MONA 15W CCT SWITCH WH
IP	IP20	IP20
Material	aluminium / pvc	aluminium / pvc
Light source	1 x LED INTEGRATED	1 x LED INTEGRATED
Power	15W	15W
Kelvins	3000 / 4000 / 6000K	3000 / 4000 / 6000K
Lumens	1200lm	1200lm
CCT	3-STEP	3-STEP
Tilt	90°	90°
Rotation	350°	350°

Colour / new index no.

○ white [AZ6037](#)● black [AZ6038](#)



MONA 18W

Technical specification

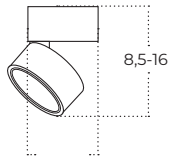

Name	MONA 18W BK	MONA 18W BK
IP	IP20	IP20
Material	aluminium	aluminium
Light source	1 x LED INTEGRATED	1 x LED INTEGRATED
Power	18W	18W
Kelvins	3000K	3000K
Lumens	1500lm	1500m
Tilt	90°	90°
Rotation	350°	350°

Colour / new index no.

- white AZ4546
- black AZ4546



ONTO

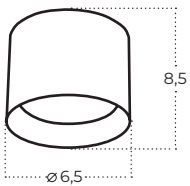

Name	ONTO BK	ONTO WH
Material	aluminium / pvc	aluminium / pvc
Light source	1 x GX53	1 x GX53

Colour / new index no.

- black AZ6265
- white AZ6266



BROSS



Name	BROSS 1 GO
IP	IP20
Material	aluminium
Light source	1 x GU10
Power	max 50W, only LED

Colour / new index no.

● aluminium	AZ0780
● black/aluminium	AZ0779
○ white	AZ0858
◐ white/aluminium	AZ0781
● chrome	AZ0857
◐ white/black	AZ1436
● black/black	AZ2135
◐ black/gold	AZ2955



black/gold



black/black



chrome



black/aluminium



white



white/black



aluminium



white/aluminium





TETRIS 10 GIPS 20W CCT DIMM

Technical specification

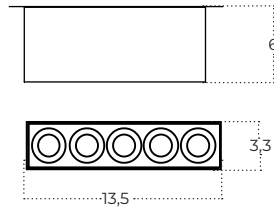

Name	TETRIS 5 10W CCT DIMM WH	TETRIS 5 10W CCT DIMM BK
IP	IP20	IP20
Material	aluminium	aluminium
Light source	1 x LED INTEGRATED	1 x LED INTEGRATED
Power	10W	10W
Kelvins	3000 / 4000 / 6000K	3000 / 4000 / 6000K
Beam angle	45°	45°
CCT	YES	YES

Colour / new index no.

● black [AZ6280](#)

○ white [AZ6279](#)



TETRIS 10 20W CCT DIMM

LED



Technical specification

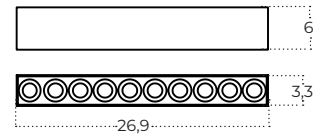

Name	TETRIS 10 20W CCT DIMM WH	TETRIS 10 20W CCT DIMM BK
IP	IP20	IP20
Material	aluminium	aluminium
Light source	1 x LED INTEGRATED	1 x LED INTEGRATED
Power	20W	20W
Kelvins	3000 / 4000 / 6000K	3000 / 4000 / 6000K
Beam angle	45°	45°
CCT	YES	YES

Colour / new index no.

● black [AZ6282](#)

○ white [AZ6281](#)

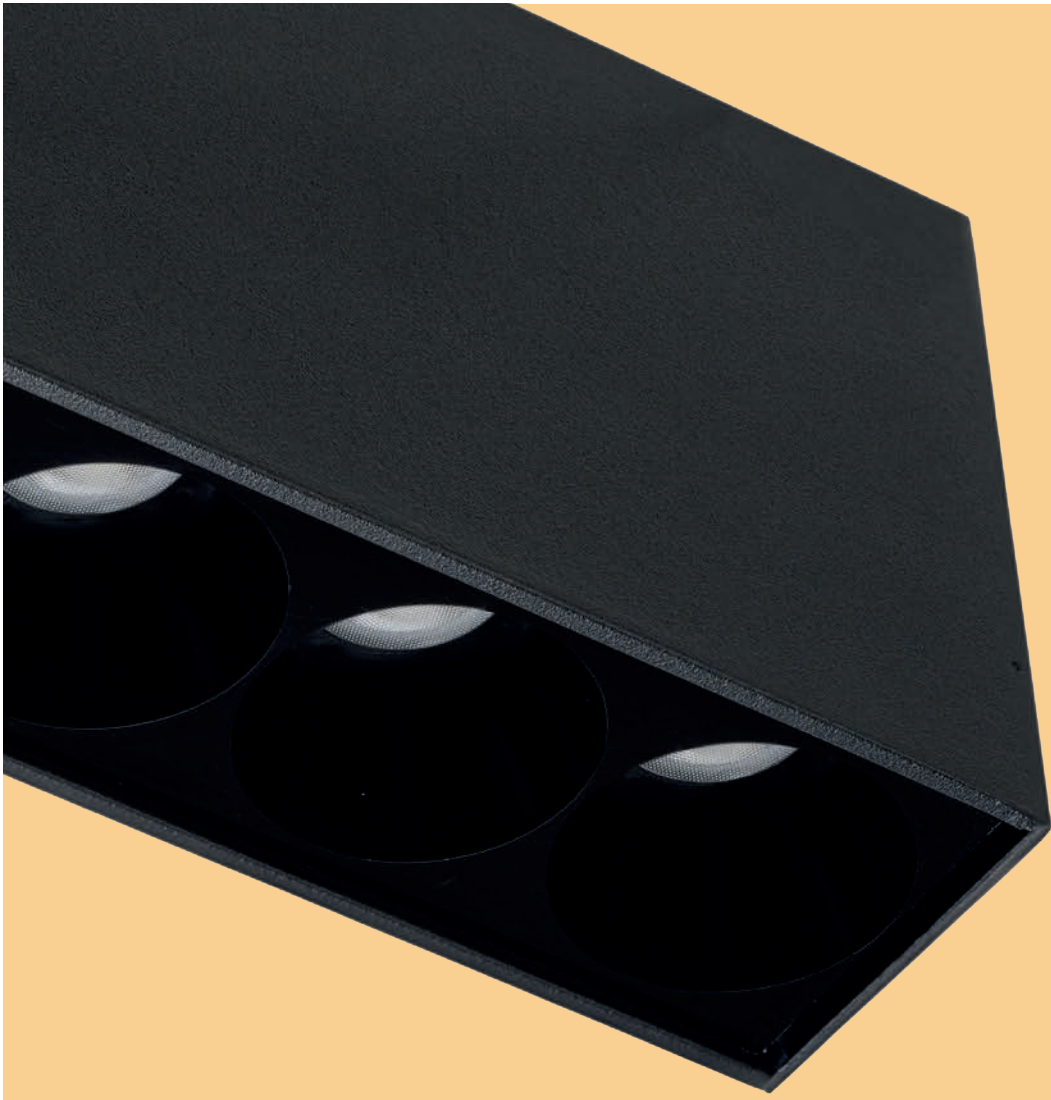

DOWNLIGHTS

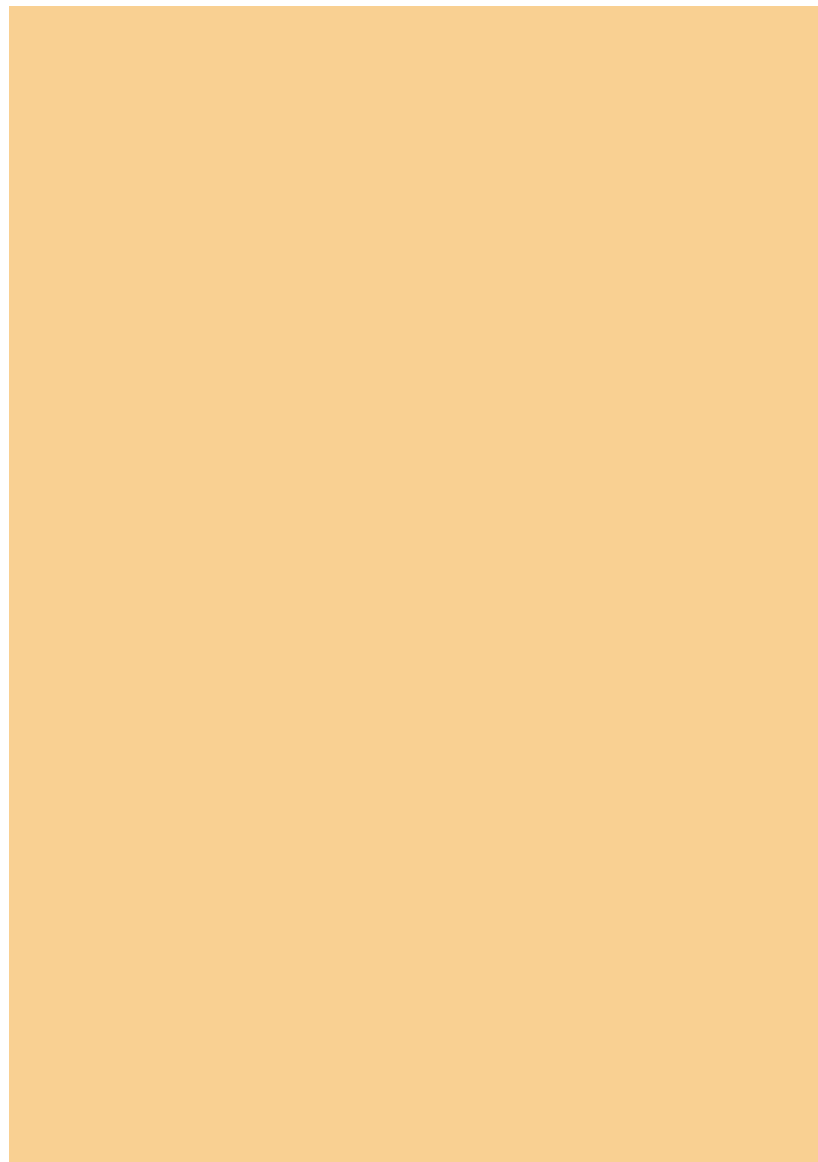



MILIS DIMM

Technical specification

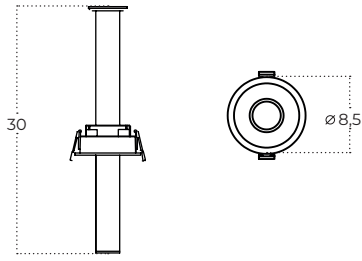

Name	MILIS DIMM BK	MILIS DIMM WH
IP	IP20	IP20
Material	aluminium	aluminium
Light source	1 x LED INTEGRATED	1 x LED INTEGRATED
Power	7W	7W
Kelvins	3230K	3230K
Lumens	326lm	326lm
Beam angle	12° - 50°	12° - 50°
CCT	N/A	N/A
Dimmable	YES	YES
Tilt	30°	30°
Rotation	360°	360°

Colour / new index no.

● black [AZ6084](#)

○ white [AZ6085](#)





TETRIS 5 GIPS 10W CCT DIMM

Technical specification

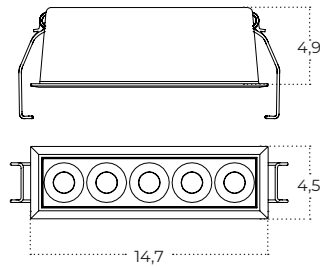

Name	TETRIS 5 GIPS 10W CCT DIMM WH	TETRIS 5 GIPS 10W CCT DIMM BK
IP	IP20	IP20
Material	aluminium	aluminium
Light source	1 x LED INTEGRATED	1 x LED INTEGRATED
Power	10W	10W
Kelvins	3000 / 4000 / 6000K	3000 / 4000 / 6000K
Beam angle	45°	45°
CCT	YES	YES

Colour / new index no.

- black [AZ6276](#)
- white [AZ6275](#)



TETRIS 10 GIPS 20W CCT DIMM

Technical specification

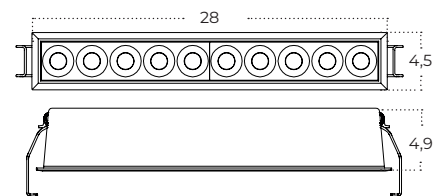

Name	TETRIS 10 GIPS 20W CCT DIMM WH	TETRIS 10 GIPS 20W CCT DIMM BK
IP	IP20	IP20
Material	aluminium	aluminium
Light source	1 x LED INTEGRATED	1 x LED INTEGRATED
Power	20W	20W
Kelvins	3000 / 4000 / 6000K	3000 / 4000 / 6000K
Beam angle	45°	45°
CCT	YES	YES

Colour / new index no.

- black [AZ6278](#)
- white [AZ6277](#)



TORK 9W

Technical specification

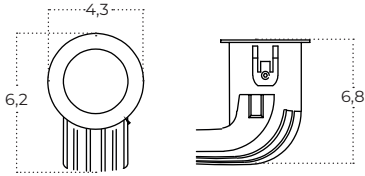

Name	TORK 9W CCT SWITCH WH/BK
IP	IP20
Material	aluminium
Light source	1 x LED INTEGRATED
Power	9W
Kelvins	3000 / 4000K
Lumens	720lm
CCT	2-STEP
Dimmable	YES

Colour / new index no.

● white/black **AZ6086**



TORK 12W

Technical specification

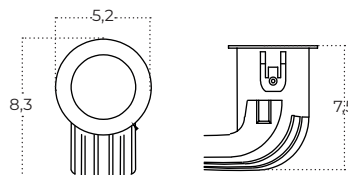

Name	TORK 12W CCT SWITCH WH/BK
IP	IP20
Material	aluminium
Light source	1 x LED INTEGRATED
Power	12W
Kelvins	3000 / 4000K
CCT	2-STEP
Dimmable	YES

Colour / new index no.

● white/black **AZ6087**







OUTDOOR





HEDDA IP54

Technical specification

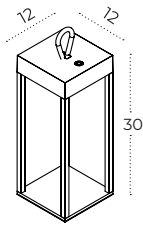

Name	Hedda IP54 BK
Power	4W
Light source	1 x LED integrated
Kelvins	3000K
Lumens	196lm
Beam angle	120°
IP	IP54
Material	aluminium
Voltage	5V
Type of control	dimmer switch + on / off switch

Colour / new index no.

● black AZ5700



IVER IP54

Technical specification

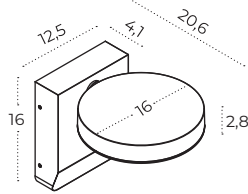

Name	Iver IP54 3000K DGR	Iver IP54 4000K DGR
Power	20W	20W
Light source	1 x LED integrated	1 x LED integrated
Kelvins	3000K	4000K
Lumens	1434lm	1484lm
Beam angle	120°	120°
IP	IP54	IP54
Material	aluminium	aluminium
Voltage	230V	230V
Rotation	355 °	355 °

Colour / new index no.

- 3000K dark grey [AZ5703](#)
- 4000K dark grey [AZ5704](#)



IVER SENSOR IP54

Technical specification

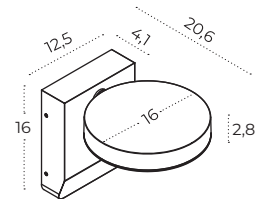

Name	Iver IP54 Sensor 3000K DGR	Iver IP54 Sensor 4000K DGR
Power	20W	20W
Light source	1 x LED integrated	1 x LED integrated
Kelvins	3000K	4000K
Lumens	1434lm	1484lm
Beam angle	120°	120°
IP	IP54	IP54
Material	aluminium	aluminium
Voltage	230V	230V
Type of control	motion sensor	motion sensor
Rotation	355 °	355 °

Colour / new index no.

- 3000K dark grey [AZ5703](#)
- 4000K dark grey [AZ5704](#)



ELIAS 30 IP65

Technical specification

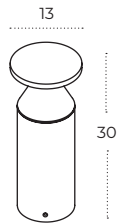

Name	Elias 30 IP65 3000K DGR	Elias 30 IP65 4000K DGR
Power	13W	13W
Light source	1 x LED integrated	1 x LED integrated
Kelvins	3000K	4000K
Lumens	668lm	694lm
Beam angle	120°	120°
IP	IP65	IP65
Material	aluminium	aluminium
Voltage	230V	230V

Colour / new index no.

- 3000K dark grey [AZ5707](#)
- 4000K dark grey [AZ5708](#)



ELIAS 60 IP65

Technical specification

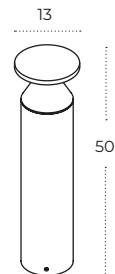

Name	Elias 60 IP65 3000K DGR	Elias 60 IP65 4000K DGR
Power	13W	13W
Light source	1 x LED integrated	1 x LED integrated
Kelvins	3000K	4000K
Lumens	668lm	694lm
Beam angle	120°	120°
IP	IP65	IP65
Material	aluminium	aluminium
Voltage	230V	230V

Colour / new index no.

- 3000K dark grey [AZ5709](#)
- 4000K dark grey [AZ5710](#)





SVERRE IP54 BK

Technical specification

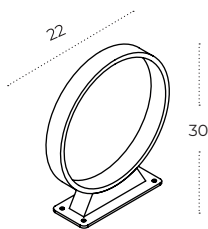

Name	Sverre IP54 BK
Power	5W
Light source	1 x LED integrated
Kelvins	3000K
Lumens	359lm
Beam angle	120°
IP	IP54
Material	aluminium
Voltage	230V

Colour / new index no.

- black AZ5711





LENNART 100 IP54

Technical specification

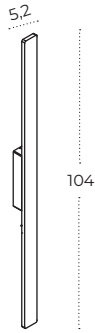

Name	Lennart 100 IP54 3000K BK	Lennart 100 IP54 4000K BK
Power	18W	18W
Light source	2 x LED integrated	2 x LED integrated
Kelvins	3000K	4000K
Lumens	1625lm	1690lm
Beam angle	120°	120°
IP	IP54	IP54
Material	aluminium	aluminium
Voltage	230V	230V

Colour / new index no.

- 3000K black [AZ5696](#)
- 4000K black [AZ5697](#)



LENNART 150 IP54

Technical specification

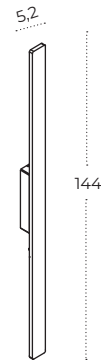

Name	Lennart 150 IP54 3000K BK	Lennart 150 IP54 4000K BK
Power	24W	24W
Light source	2 x LED integrated	2 x LED integrated
Kelvins	3000K	4000K
Lumens	2342lm	2433lm
Beam angle	120°	120°
IP	IP54	IP54
Material	aluminium	aluminium
Voltage	230V	ON / OFF SWITCH

Colour / new index no.

- 3000K black [AZ5689](#)
- 4000K black [AZ5699](#)







ALVA 60 IP54

Technical specification

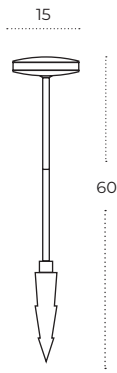

Name	Alva 60 IP54 DGR
Power	12W
Light source	1 x LED integrated
Kelvins	3000K
Lumens	646lm
Beam angle	120°
IP	IP54
Material	aluminium / pvc
Voltage	230V

Colour / new index no.

- dark grey AZ5705



ALVA 610 IP54

Technical specification

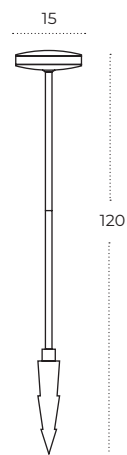

Name	Alva 610 IP54 DGR
Power	12W
Light source	1 x LED integrated
Kelvins	3000K
Lumens	646lm
Beam angle	120°
IP	IP54
Material	aluminium / pvc
Voltage	230V

Colour / new index no.

- dark grey AZ5706



DURANTE IP54 4000K BK

Technical specification

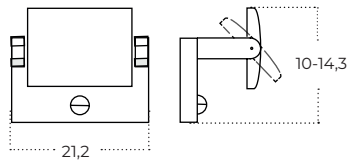

Name	Durante IP54 4000K BK
Power	21W
Light source	1 x LED integrated
Kelvins	4000K
Lumens	1418lm
Beam angle	120°
IP	IP54
Material	aluminium / pvc
Voltage	230V

Colour / new index no.

- 4000K black AZ5712



SVALA IP54 CCT SWITCH



Technical specification

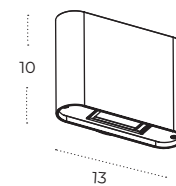

Name	Svala IP54 CCT Switch BK	Svala IP54 CCT Switch DGR
Power	6W	6W
Light source	2 x LED integrated	2 x LED integrated
Kelvins	3000 / 4000K	3000 / 4000K
Lumens	480lm	480lm
IP	IP54	IP54
Voltage	230V	230V
Type of control	CCT SWITCH	CCT SWITCH

Colour / new index no.

- black AZ5855
- dark grey AZ5856





CONYON IP54 10W CCT Switch

Technical specification

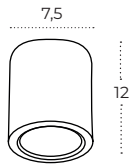

Name	Conyon IP54 10W CCT Switch
Power	10W
Light source	1 x LED integrated
Kelvins	3000 / 4000 / 6000K
Lumens	800lm
Beam angle	120°
IP	IP54
Material	aluminium
Voltage	230V
Type of control	CCT switch

Colour / new index no.

- black AZ6025
- white AZ6026



CONYON IP54 15W CCT Switch

Technical specification

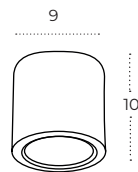

Name	Conyon IP54 15W CCT Switch
Power	10W
Light source	1 x LED integrated
Kelvins	3000 / 4000 / 6000K
Lumens	1200lm
Beam angle	120°
IP	IP54
Material	aluminium
Voltage	230V
Type of control	CCT switch

Colour / new index no.

- black AZ6027
- white AZ6028





CONYON IP54 25W CCT Switch

Technical specification

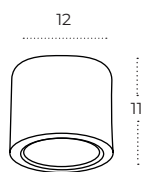

Name	Conyon IP54 25W CCT Switch
Power	10W
Light source	1 x LED integrated
Kelvins	3000 / 4000 / 6000K
Lumens	2000lm
Beam angle	120°
IP	IP54
Material	aluminium
Voltage	230V
Type of control	CCT switch

Colour / new index no.

- black AZ6029

- white AZ6030



ROTOR IP65

Name	Rotor IP65
Light source	1 x E27
IP	IP65
Material	aluminium

Colour / new index no.

- black AZ6075

- white AZ6066

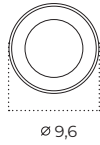
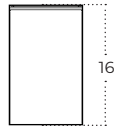

PAPIKO IP65

Name	Papiko IP65 GO
Light source	1 x GU10
IP	IP65
Material	aluminium
Voltage	230V

Colour / new index no.

- black AZ4216

- white AZ4217

- gold AZ6077 new

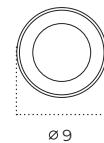
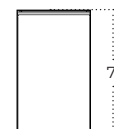



ERIN IP54

Technical specification

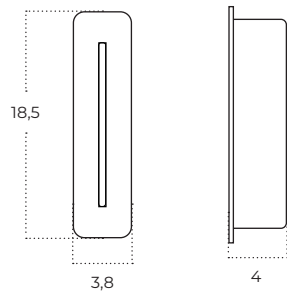

Name	Erin IP54 WH	Erin IP54 BK
Power	3W	3W
Light source	1 x LED integrated	1 x LED integrated
Kelvins	3100K	3100K
Lumens	10,5lm	10,5lm
Beam angle	N/A	N/A
IP	IP54	IP54
Material	aluminium	aluminium
Voltage	230V	230V

Colour / new index no.

- black AZ6080
- white AZ6078



ERIN SENSOR IP54

Technical specification

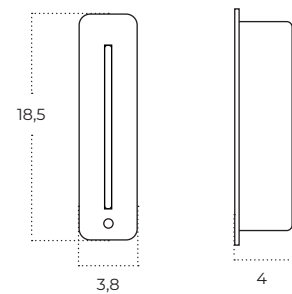

Name	Erin IP54 Sensor WH	Erin IP54 Sensor BK
Power	3W	3W
Light source	1 x LED integrated	1 x LED integrated
Kelvins	3100K	3100K
Lumens	10,5lm	10,5lm
IP	IP54	IP54
Material	aluminium	aluminium
Voltage	230V	230V
Type of control	MOTION SENSOR	MOTION SENSOR

Colour / new index no.

- black AZ6081
- white AZ6079



AROS IP67 ST

Technical specification

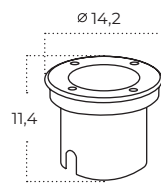

Name	Aros IP67 3000K ST	Aros IP67 4000K ST
Power	12W	12W
Light source	1 x LED integrated	1 x LED integrated
Kelvins	3000K	4000K
Lumens	960lm	960lm
IP	IP67	IP67
Material	metal	metal
Voltage	230V	230V

Colour / new index no.

- 3000K stainless steel [AZ5843](#)
- 4000K stainless steel [AZ5844](#)





SILL WALL IP54

Technical specification

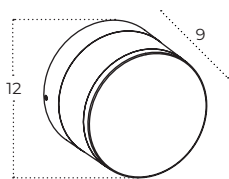

Name	Sill Wall IP54 3000K BK
Power	9W
Light source	1 x LED integrated
Kelvins	3000K
Lumens	720lm
IP	IP54
Voltage	230V

Colour / new index no.

- black AZ5845



SILL IP54

Technical specification

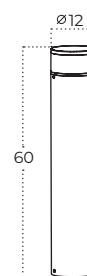

Name	Sill IP54 3000K BK
Power	9W
Light source	1 x LED integrated
Kelvins	3000K
Lumens	720lm
IP	IP54
Voltage	230V

Colour / new index no.

- black AZ5846

SVAN IP54 BK

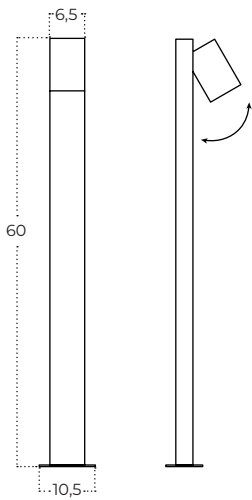

Name	Svan IP54 BK
Power	35W
Light source	1 x GU10
IP	IP54
Material	aluminium / pvc
Voltage	230V

Colour / new index no.

● black AZ5859

SVAN SENSOR IP54 BK

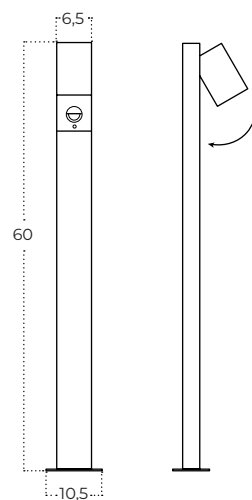
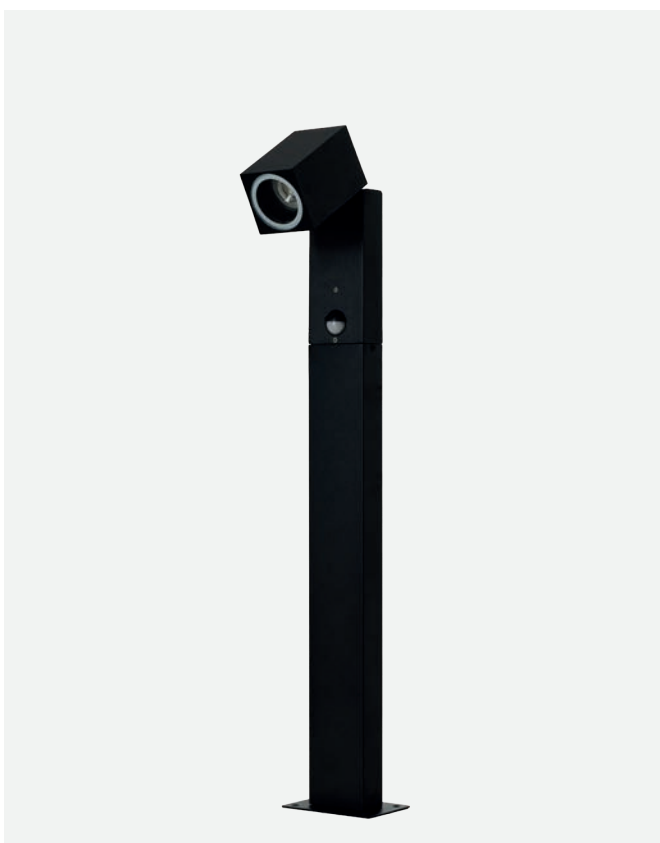

Name	Svan Sensor IP54 BK
Power	35W
Light source	1 x GU10
IP	IP54
Material	aluminium / pvc
Voltage	230V
Type of control	MOTION SENSOR

Colour / new index no.

● black AZ5860

TRAST 1 IP54 BK

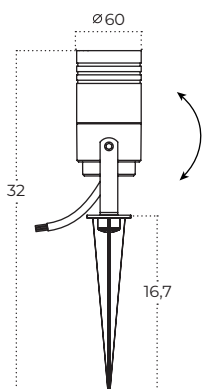

Name	TraST 1 IP54 BK
Power	35W
Light source	1 x GU10
IP	IP54
Material	aluminium / pvc
Voltage	230V

Colour / new index no.

- black AZ5861

TRAST 2 IP54 BK

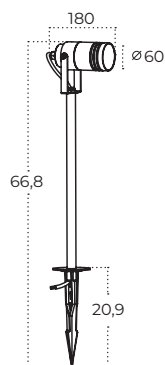

Name	TraST 2 IP54 BK
Power	35W
Light source	1 x GU10
IP	IP54
Material	aluminium / pvc
Voltage	230V

Colour / new index no.

- black AZ5862



ROSVIK 25 IP54 3000K

Technical specification

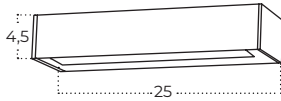

Name	Rosvik 25 IP54 6W 3000K BK	Rosvik 25 IP54 2X 6W 3000K BK
Power	6W	12W
Light source	1 x LED integrated	2 x LED integrated
Kelvins	3000K	3000K
Lumens	480lm	960lm
IP	IP54	IP54
Voltage	230V	230V

Colour / new index no.

- 6W black [AZ5847](#)
- 2 x 6W black [AZ5848](#)



ROSVIK 50 IP54 3000K

Technical specification

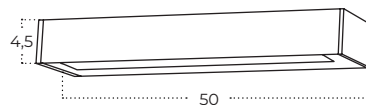

Name	Rosvik 50 IP54 10W 3000K BK	Rosvik 50 IP54 2X 10W 3000K BK
Power	10W	20W
Light source	1 x LED integrated	2 x LED integrated
Kelvins	3000K	3000K
Lumens	800lm	1600lm
IP	IP54	IP54
Voltage	230V	230V

Colour / new index no.

- 10W black [AZ5849](#)
- 2 x 10W black [AZ5850](#)





ROSVIK 25 IP54 4000K

Technical specification

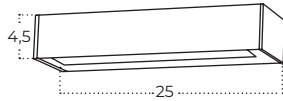

Name	Rosvik 25 IP54 6W 4000K BK	Rosvik 25 IP54 2X 6W 4000K BK
Power	6W	12W
Light source	1 x LED integrated	2 x LED integrated
Kelvins	4000K	4000K
Lumens	480lm	960lm
IP	IP54	IP54
Voltage	230V	230V

Colour / new index no.

- 6W black [AZ5851](#)
- 2 x 6W black [AZ5852](#)



ROSVIK 50 IP54 4000K

Technical specification

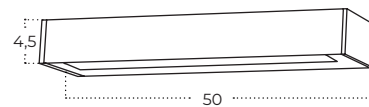

Name	Rosvik 50 IP54 10W 4000K BK	Rosvik 50 IP54 2X 10W 4000K BK
Power	10W	20W
Light source	1 x LED integrated	2 x LED integrated
Kelvins	4000K	4000K
Lumens	800lm	1600lm
IP	IP54	IP54
Voltage	230V	230V

Colour / new index no.

- 10W black [AZ5853](#)
- 2 x 10W black [AZ5854](#)

HAGER 1 WALL IP54 BK

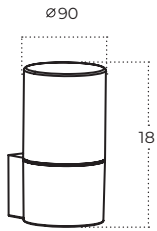

Name	Hager 1 Wall IP54 BK
Power	18W
Light source	1 x E27
IP	IP54
Material	pvc
Voltage	230V

Colour / new index no.

● black AZ5863



HAGER 2 WALL IP54 BK

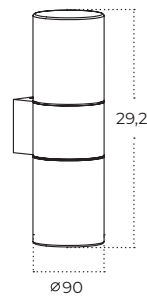

Name	Hager 2 Wall IP54 BK
Power	36W
Light source	2 x E27
IP	IP54
Material	pvc
Voltage	230V

Colour / new index no.

● black AZ5864

HAGER 50 IP54 BK

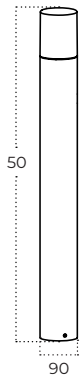

Name	Hager 50 IP54 BK
Power	18W
Light source	1 x E27
IP	IP54
Material	pvc
Voltage	230V

Colour / new index no.

● black AZ5865

